

# Data Sheet



Article number: 201017098

Description: E+G Clamping jaw blank GN 872-50-80

## Measures

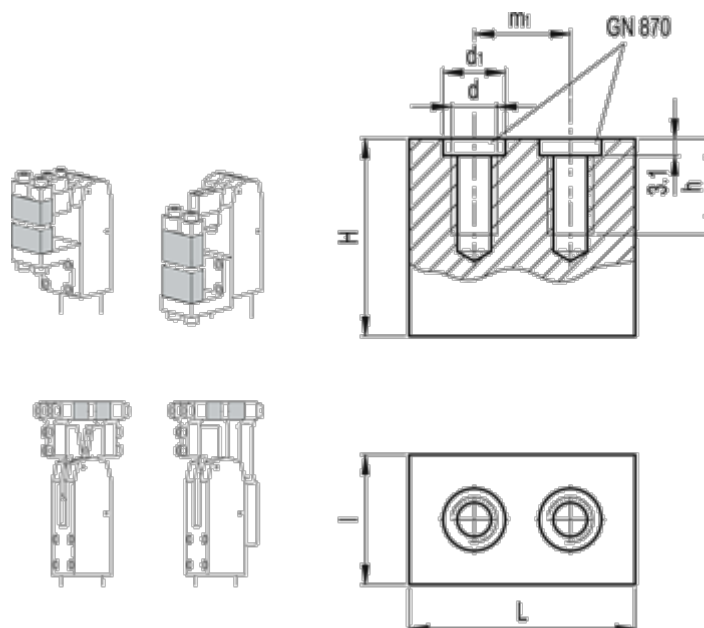

d	= M10
d1 H8/h6	= 13
h	= 20
H	= 80
l	= 20
L	= 50
m1	= 30
Weight (g)	= 580